

Special
Session
2C



Tag Measurement Principles

Pavel Nikitin
Intermec Technologies



6001 36th Ave W, Everett, WA, 98203, USA

Outline

- Tag and system characteristics
- Measurement methods
- Conducted measurements
- Test system example
- Conclusions

Tag and System Characteristics

- Tag

- Sensitivity P_{tag}

- Backscatter efficiency χ

- System

- Forward range $r_{forward}$

- Reverse range $r_{reverse}$

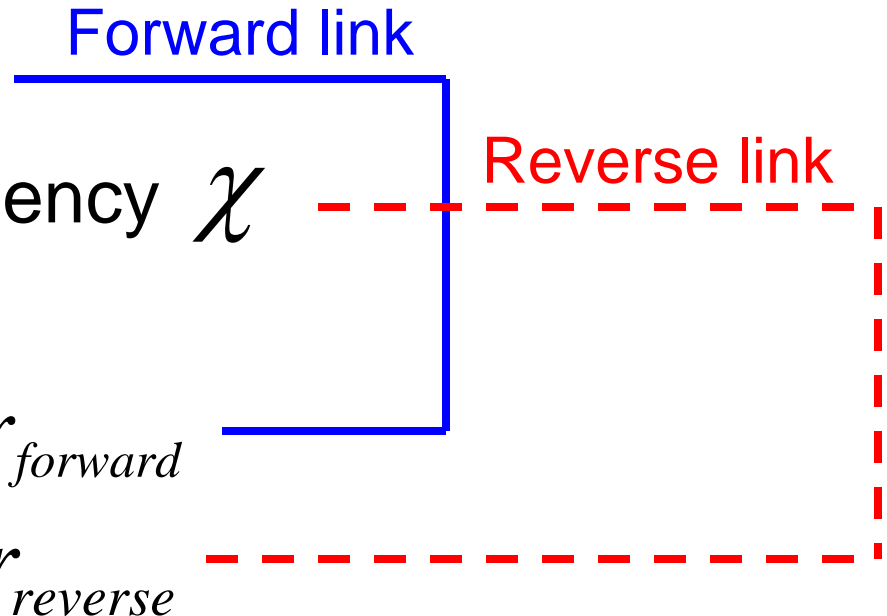

Sensitivity: $P_{tag} [W], E_{tag} [V / m]$

- Minimum incident power (or field) needed to turn on the tag

$$P_{tag} = \frac{P_{chip}}{G \tau} = \frac{E_{tag}^2}{120\pi} \cdot \frac{\lambda^2}{4\pi}$$

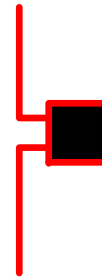

$$\tau = \frac{4R_{c_1} R_a}{|Z_{c_1} + Z_a|^2}$$

P_{chip} – chip sensitivity

G – gain of the tag
antenna

τ – tag impedance
matching coefficient

Z_a – antenna impedance

$Z_{c_{1,2}}$ – chip impedances (1 and 2)

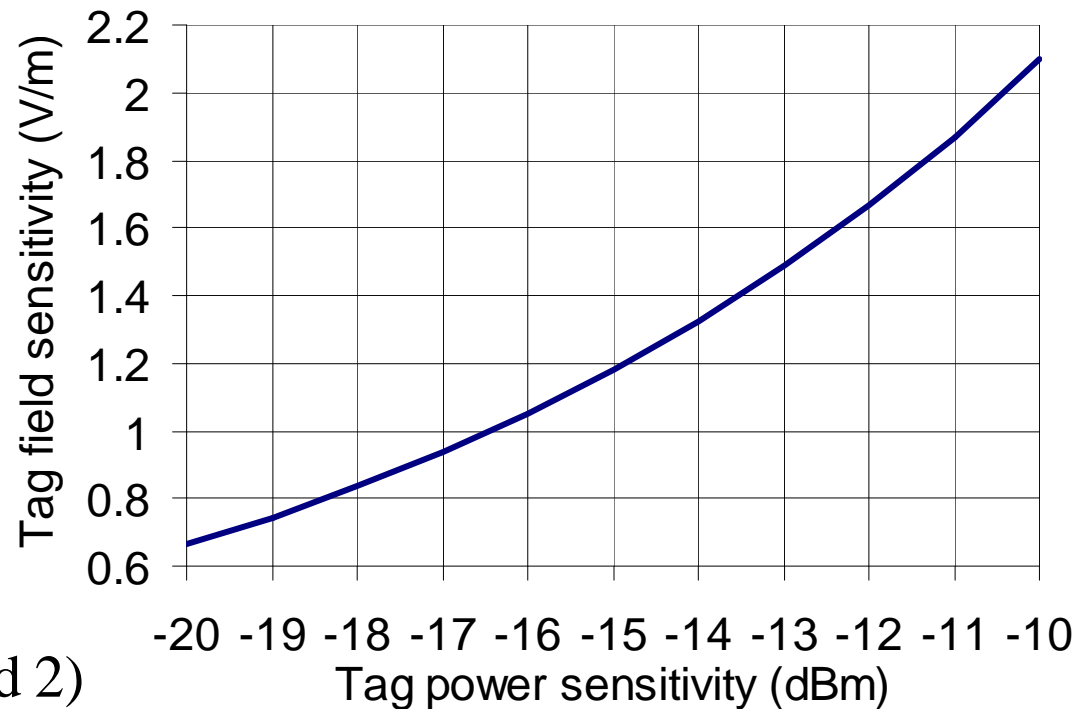

Backscatter Efficiency: χ [dB]

- How much of incident RF power is “converted” to modulated backscatter

$$\chi = p^2 G^2 K = \frac{4\pi \Delta\sigma}{\lambda^2}$$

- Depends on incident power, waveform details

$$K = \alpha |\rho_1 - \rho_2|^2$$

K – tag modulation loss

$\Delta\sigma$ – tag differential RCS

$\rho_{1,2}$ – complex reflection coefficients

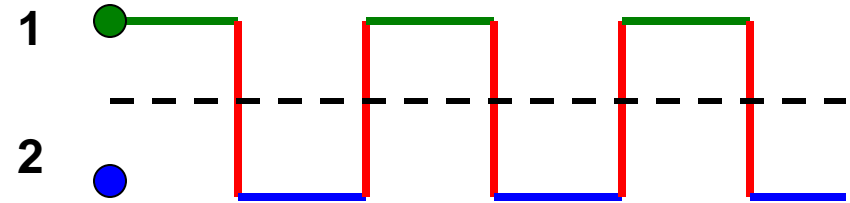

State 1	Matched	Matched	Short
State 2	Short	Open	Open
rho1	0	0	-1
rho2	-1	1	1
alpha	1/4	1/4	1/4
K	-6 dB	-6 dB	0 dB

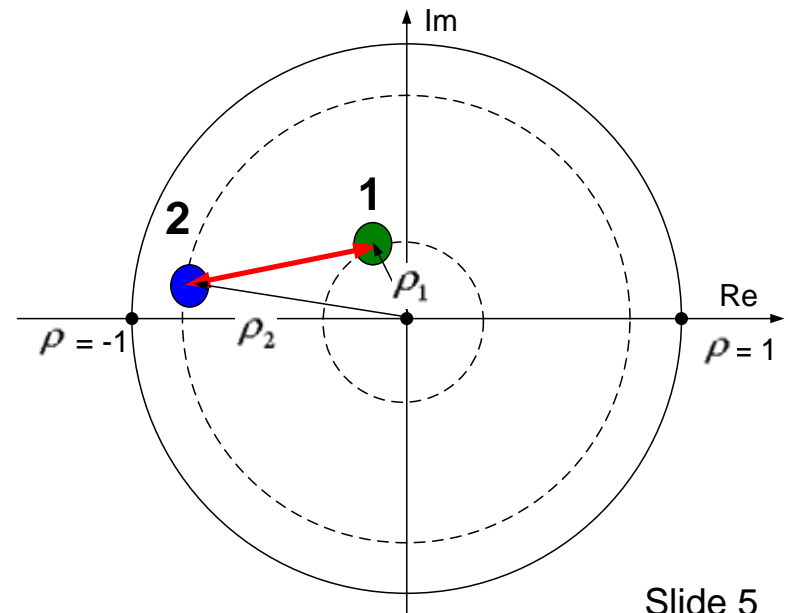

Forward Range

- Maximum distance at which tag can be read (or written to)
- Depends on the tag, the environment, and reader power
- In free space:

$$r_{forward} = \frac{\lambda}{4\pi} \sqrt{\frac{P_t G_t}{P_{tag}}}$$

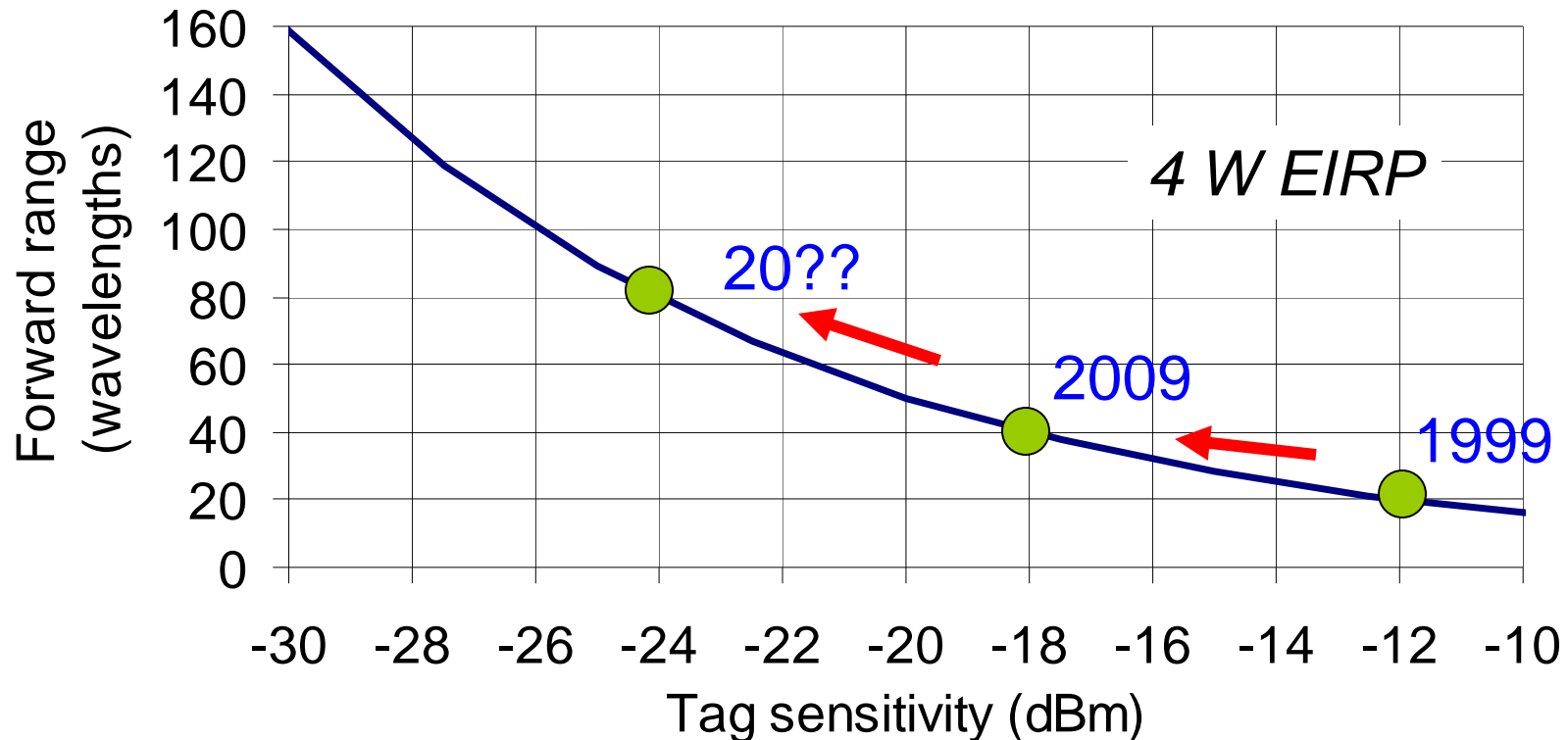

Reverse Range

- Maximum distance at which tag signal can be received
- Depends on the tag, the environment, and reader power and sensitivity
- In free space:

$$r_{reverse} = \frac{\lambda}{4\pi} \left(\frac{P_t G_t^2 \chi}{P_{reader}} \right)^{1/4}$$

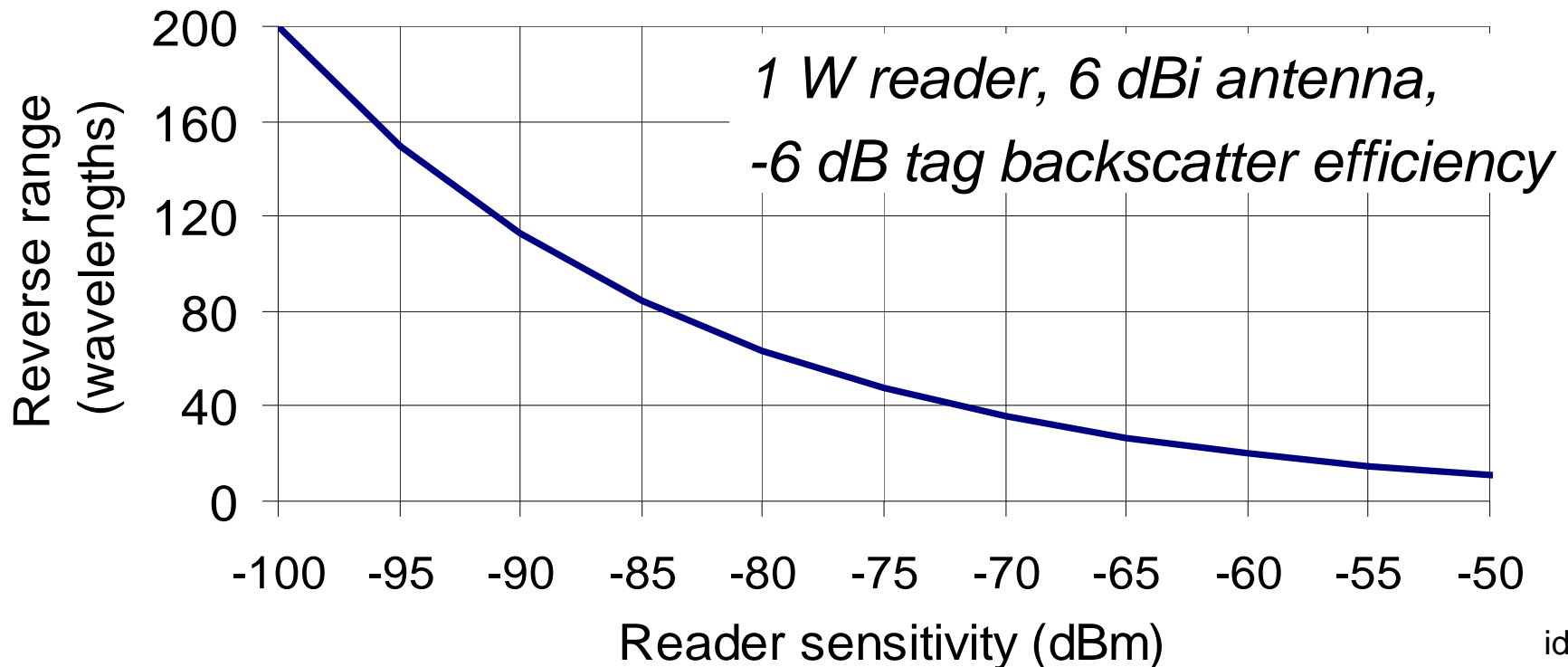

Reader Sensitivity vs. Tag Sensitivity

- Minimum reader sensitivity needed to read a tag of certain sensitivity at its maximum range:
- Valid for any environment (path loss is embedded into formula)

$$P_{reader} = \frac{P_{tag}^2}{P_t} \chi$$

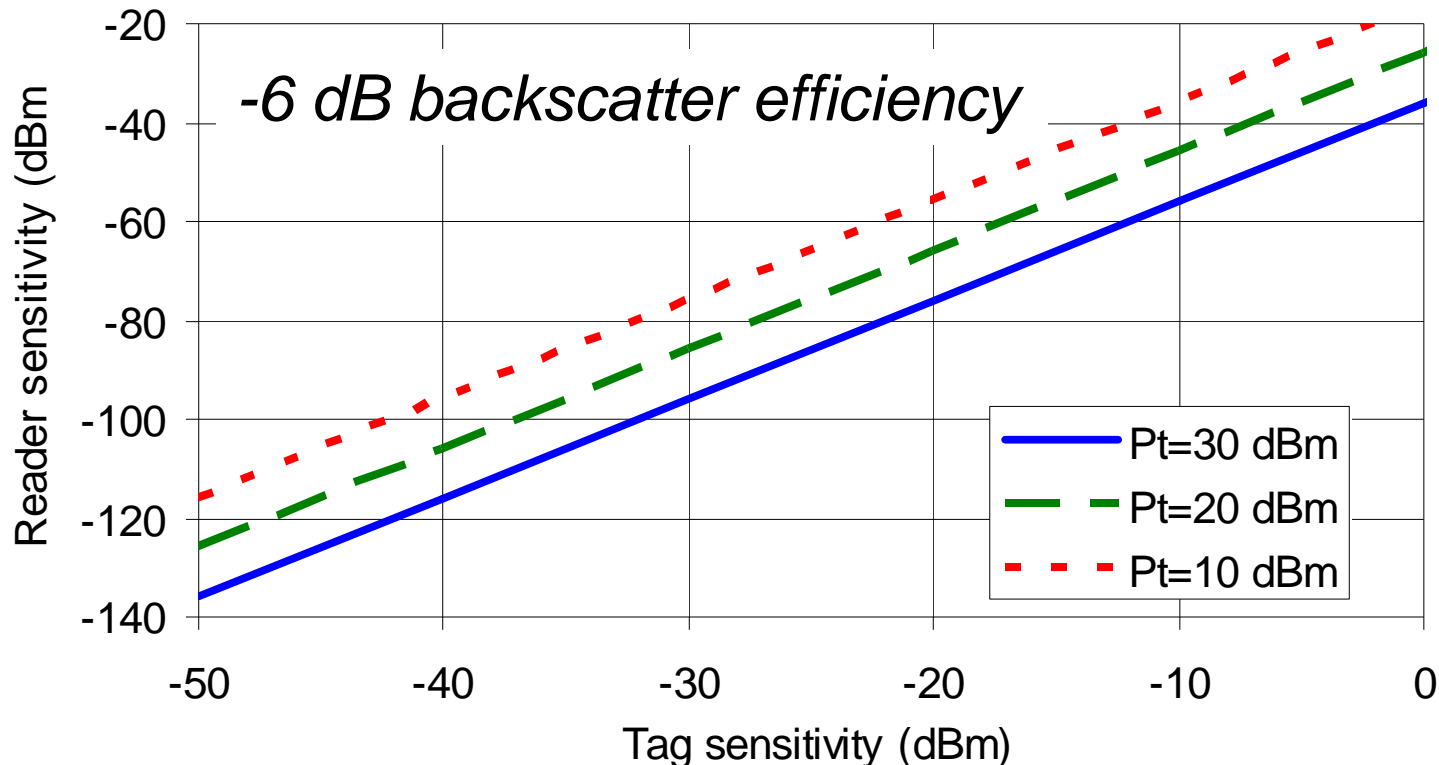

Tag Measurement Methods

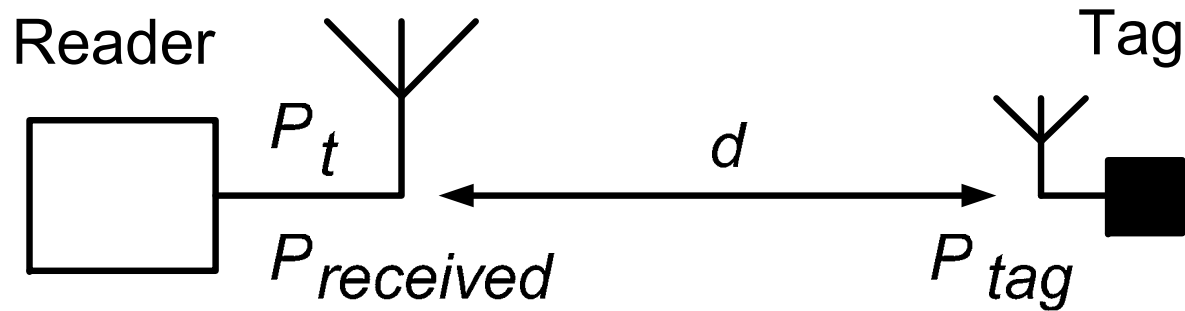

- Varied distance ($P = \text{const}$)
- Varied power ($d = \text{const}$)
- Measure transmitted and received power
- In free space:

$$P_{tag} = P_t G_t \left(\frac{\lambda}{4\pi d} \right)^2 \quad P_{received} = P_t G_t^2 \left(\frac{\lambda}{4\pi d} \right)^4 \chi$$

Controlled Test Environment

1. Anechoic chamber

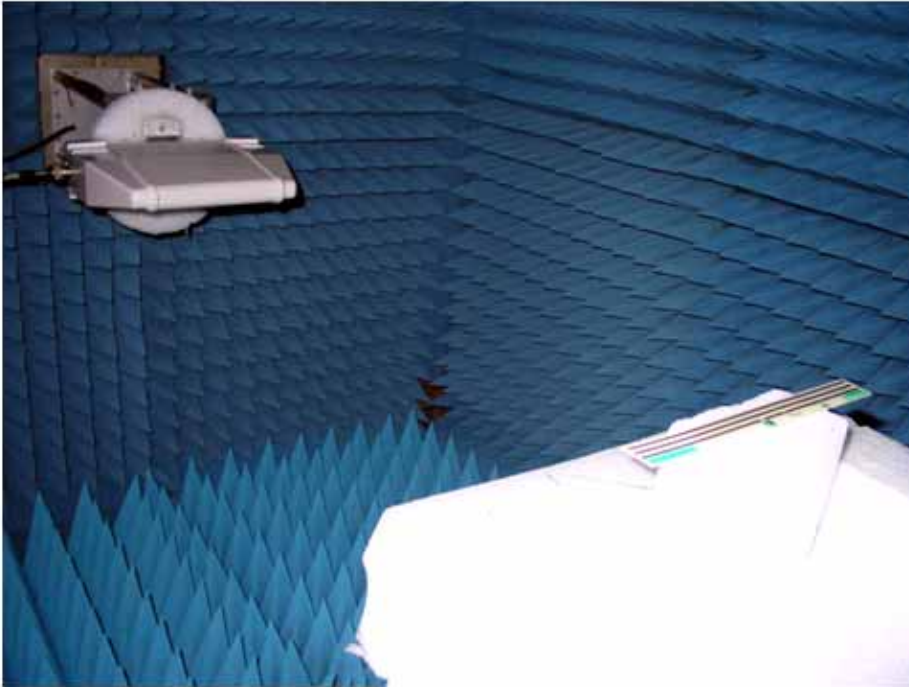

2. TEM cell



3. Free space

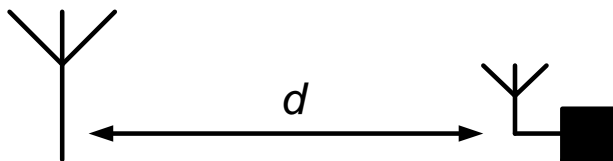

$$E_{\min} = \frac{V_{\min}}{h} = \frac{\sqrt{P_{\min} Z}}{h}$$

h – cell height at tag location

Conducted Measurements

- Unmatched chips
 - Threshold sensitivity
 - Input impedance
- Matched chips
 - Reader testing
 - Antenna measurements

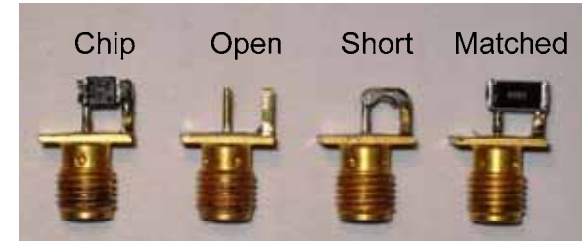
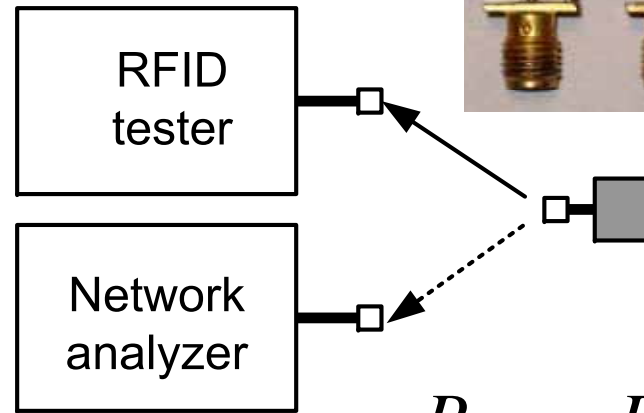

$$P_{chip} = P_{min} \left(1 - |S_{11}|^2 \right)$$

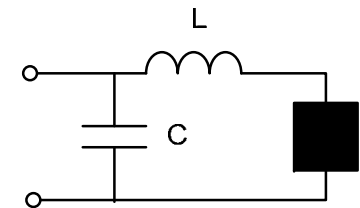
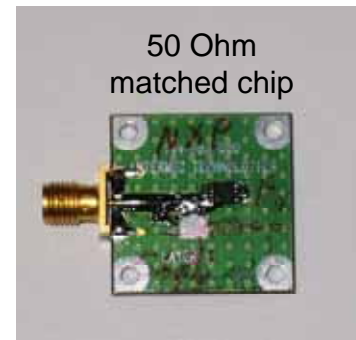
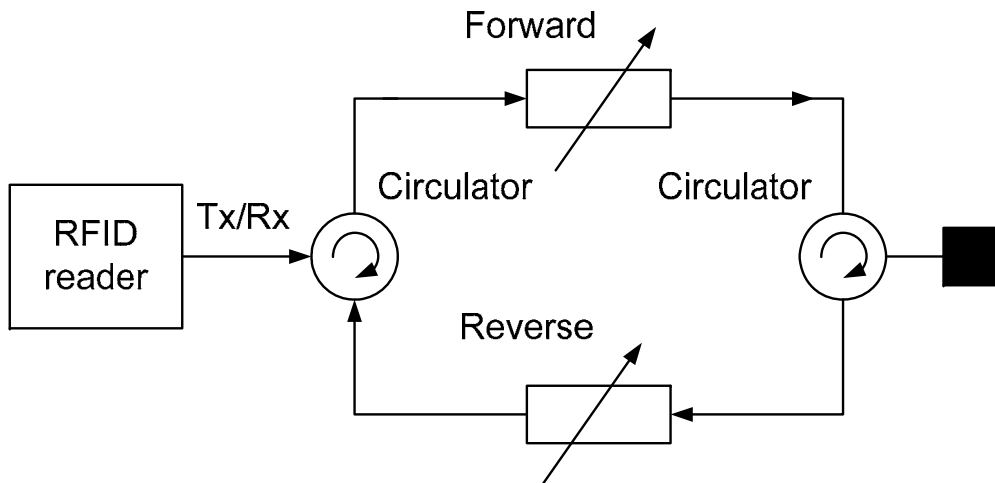

Test System Example

- National Instruments LabVIEW PXI RF platform
- Controlled:
 - Power (max. 30 dBm, 0.1 dB step)
 - Frequency (800-100 MHz)
 - Gen2 protocol parameters (link timing, modulation)

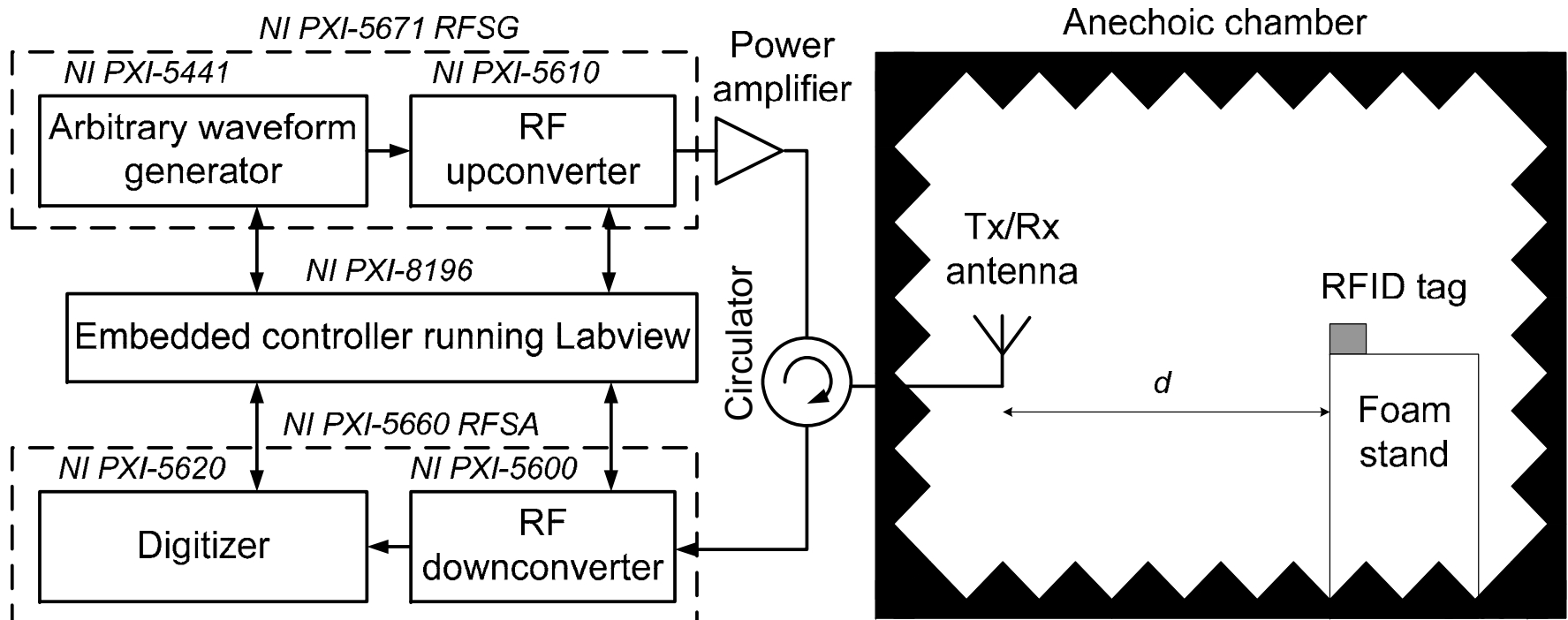
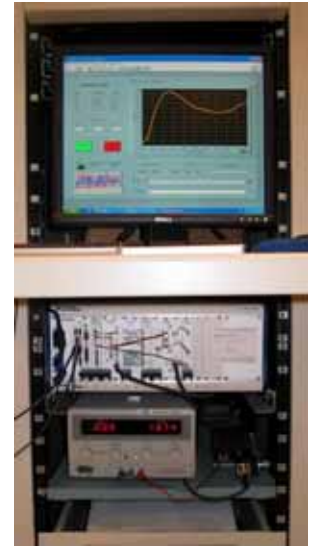

Processing I and Q

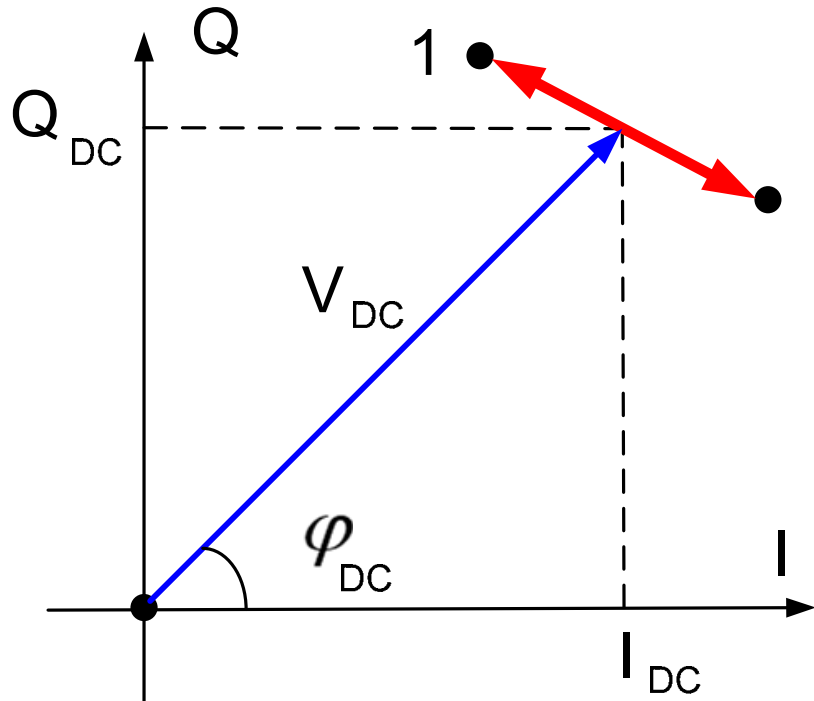

$$I = I_{DC} + I_{AC}$$

$$Q = Q_{DC} + Q_{AC}$$

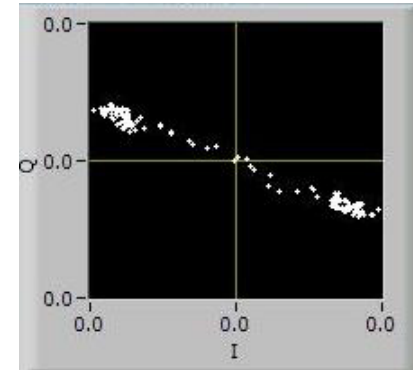

Remove DC

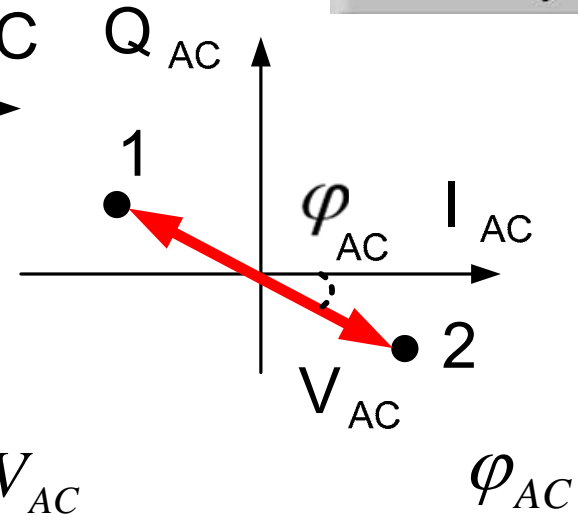

I_{AC}

Q_{AC}

V_{AC}

φ_{AC}

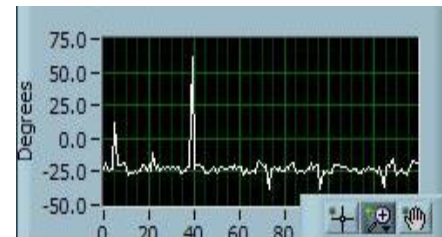
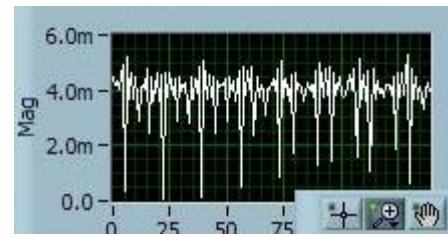
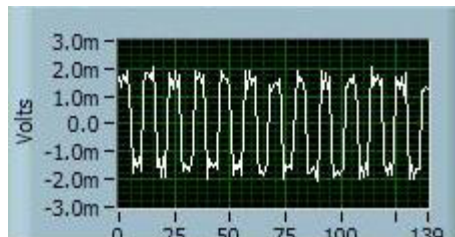
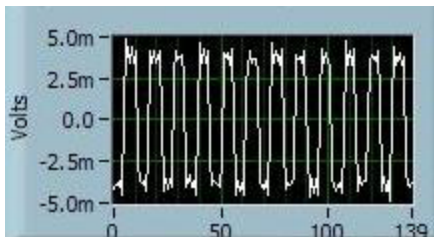

Tag Detection and Power Calculation

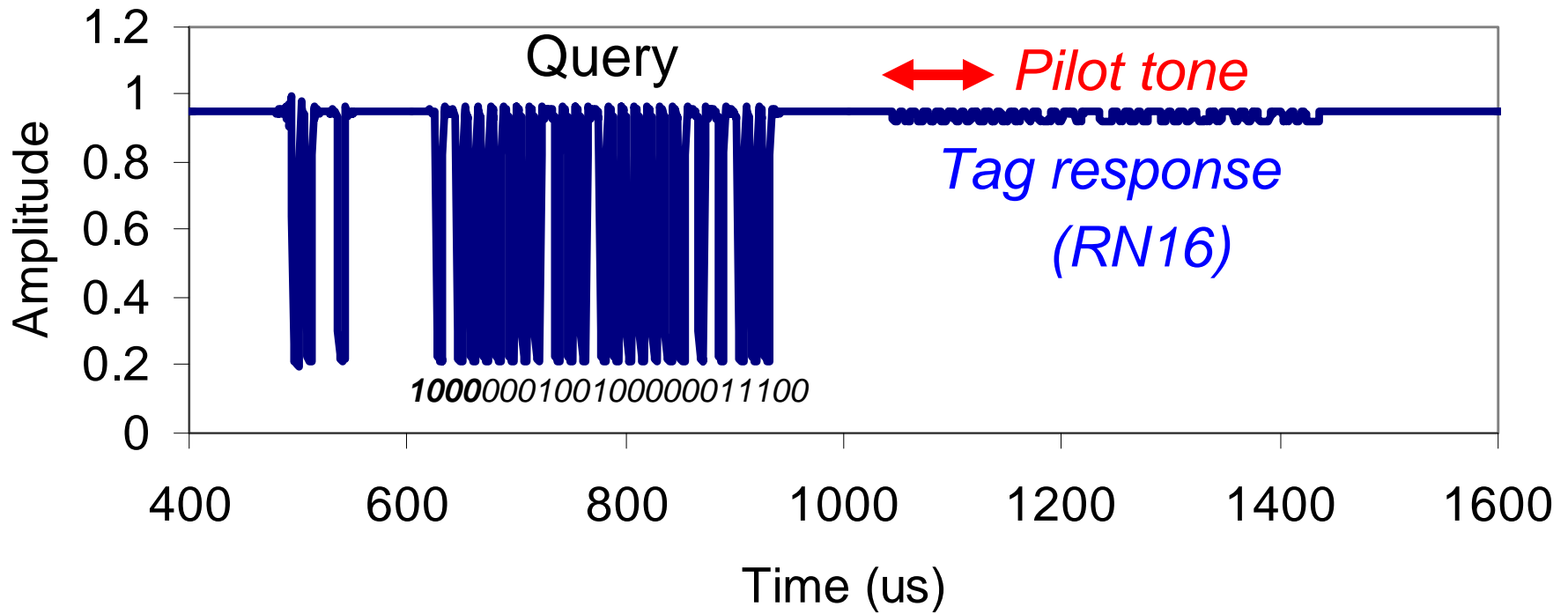

- Tag response detection (frequency domain)
 - Look for spectral component around expected BLF
- Received power calculation (time domain)
 - Average power in pilot tone

$$P_{received} = \frac{\langle V_{AC}^2 \rangle}{Z_o}$$

Conclusions

- Forward and reverse link measurements are important (especially for BAP tags)
- Accurate characterization requires:
 - RFID reader with power and frequency control
 - Controlled test environment
 - Careful RF calibration
- Challenges: characterizing tag performance in presence of other tags and readers

Thank you!



Questions or comments?

pavel.nikitin@intermec.com